

# CPAP/Auto CPAP/BIPAP ST25 / ST30

## User Guide



## Product

The DS-5 is Positive Airway Pressure (CPAP) device.

The DS-6 is Auto-adjusting Pressure (Auto CPAP) device.

The DS-7 is Bilevel Positive Airway Pressure ST25 (BIPAP ST25) device.

The DS-8 is Bilevel Positive Airway Pressure ST30 (BIPAP ST30) device.

CPAP mode provide same inspiratory and expiratory therapy pressure in one breathing cycle, Bilevel mode provide different inspiratory and expiratory therapy pressure.

### **WARNING**

Read this entire guide before using the device.

### **CAUTION**

In the US, Federal law restricts this device to sale by or on the order of a physician.

#### **Indications for use**

The CPAP and Auto CPAP is indicated for the treatment of obstructive sleep apnea (OSA) in patients weighing more than 66 lb (30 kg). The humidifier is integrated in device.

The BIPAP ST25 and BIPAP ST30 are indicated for the treatment of obstructive sleep apnea (OSA)/ central sleep apnea (CSA)/ mixed sleep apnea (MSA) in patients weighing more than 66 lb (30 kg). The humidifier is integrated in device.

The device is intended for use in professional healthcare institutions, cannot be used in home healthcare environment.

## Adverse effects

You should report severe headache, unusual chest pain or increased breathlessness to your prescribing physician. An acute upper respiratory tract infection may require temporary discontinuation of treatment.

The following side effects may arise during the course of therapy with the device:

- ◆ drying of the nose, mouth, or throat
- ◆ nosebleed
- ◆ bloating
- ◆ ear or sinus discomfort

- ◆ eye irritation
- ◆ skin rashes.

## Contraindications

Positive airway pressure therapy may be contraindicated in some patients with the following pre-existing conditions:

- ◆ pneumothorax
- ◆ dehydration
- ◆ severe bullous lung disease
- ◆ pathologically low blood pressure
- ◆ cerebrospinal fluid leak, trauma recent, or cranial surgery.

## Packing list of the device

- ◆ Device with integrated humidifier
- ◆ Water tank
- ◆ Power supply unit
- ◆ Travel bag
- ◆ Measuring cup

Contact your care provider for a range of accessories available for use with the device including: Air tubing/Air filter/Mask

Use the mask/air tubing that complies with ISO17510/ISO80601-2-70/EN ISO10993.



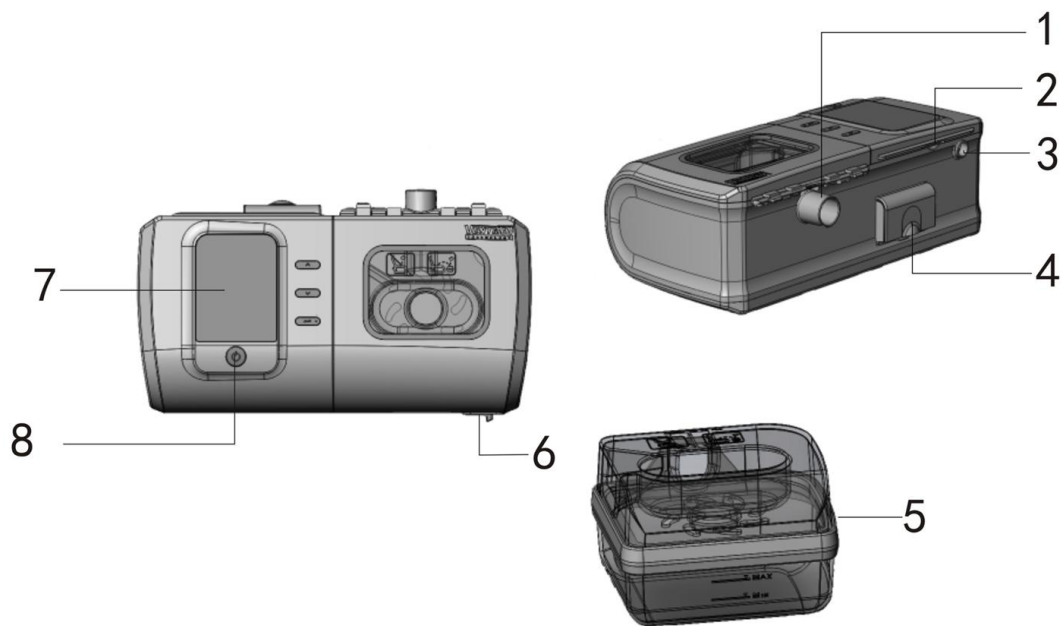

 **WARNING:** Failure to use a mask or accessory that minimizes rebreathing of carbon dioxide or permits spontaneous breathing can cause asphyxiation.

# About device



- |   |                  |   |  |
|---|------------------|---|--|
| 1 | Air outlet       | 5 | Water tank                                     |
| 2 | SD card slot     | 6 | Water tank open switch                         |
| 3 | Power inlet      | 7 | Screen   |
| 4 | Air filter cover | 8 | Start/Stop button: Press to start/stop therapy |

## About the control panel

- |   |                   |                                   |
|---|-------------------|-----------------------------------|
|  | Start/Stop button | Press to start/stop therapy.      |
|  | Up button         | Press to select previous item.    |
|  | Down button       | Press to select next item.        |
|  | Enter button      | Press to enter the selected item. |

Different icons may be displayed on the screen at different times including:



Machine is working



Ramp time



Humidifier Level



SD Card

## Setup



### **⚠ CAUTION**

**Do not overfill the water tank as water may enter the device and air tubing.**

1. Place the device on a stable level surface.
2. Plug the power connector into the rear of the device. Connect one end of the power cord into the power supply unit and the other end into the power outlet.
3. Connect the air tubing firmly to the air outlet located on the rear of the device.
4. Open the water tank cover and fill it with distilled water up to the maximum water level mark. Do not fill hot water in the water tank.
5. Close the water tank cover.
6. Connect the free end of the air tubing firmly onto mask. For detailed information, read the mask user guide.
7. Physician should ensure the compatibility of the equipment and all of the parts

and accessories used to connect to the patient before use; should ensure that the therapeutic pressure settings were determined for the patient individually with the configuration of the equipment to be used, including accessories; and should periodically reassess the setting(s) of the therapy for effectiveness.

8. The equipment must not be covered or positioned in such a way that the operation or performance of the equipment is adversely affected.

## Starting therapy

1. Fit your mask.
2. Press Start/Stop button.
3. You will know that therapy is on when the air fan icon is rotated .

The current treatment pressure is shown in white words.

During ramp time the pressure is gradually increasing and you will see a blue triangle icon on the screen once the prescribed pressure is reached.

The screen will go black automatically after a short period of time. You can press any button to turn it back on.

## Stopping therapy

1. Remove mask.
2. Press Start/Stop button, therapy will stop automatically after a few seconds.

The Sleep Report now gives you a summary of therapy session.

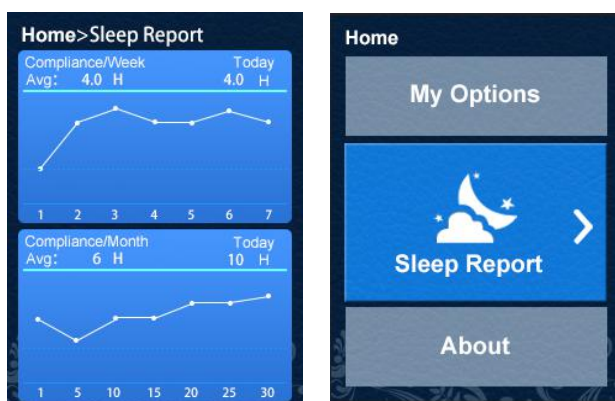

Compliance/Week Avg: H--Indicated the number of hours of therapy you received in one week.

H Today--Indicated the number of hours of therapy you received today.

Compliance/Month: H--Indicated the number of hours of therapy you received in

one month.

## Sleep Report

1. In work interface, press Up or Down button to check sleep report date and waveform.



W M: Work Mode

Insp T: Inspiratory Time

Leak: Air Leakage

Press: Therapy Pressure

M V: Minute Volume

BPM: Breaths Per Minute

T V: Tidal Volume

Exp T: Expiratory Time

## My Options

The device has been set up for your needs by your care provider, but you may want to make small adjustments to make your therapy more comfortable.

Highlight **My Options** and press Up/Down button to see current setting. You can personalize your options.

## Ramp Time

Designed to make the beginning of therapy more comfortable, Ramp Time is the period during which the pressure increases from a low start pressure to the prescribed treatment pressure. You can set Ramp Time from 0 to 60minutes.

## To adjust Ramp Time:

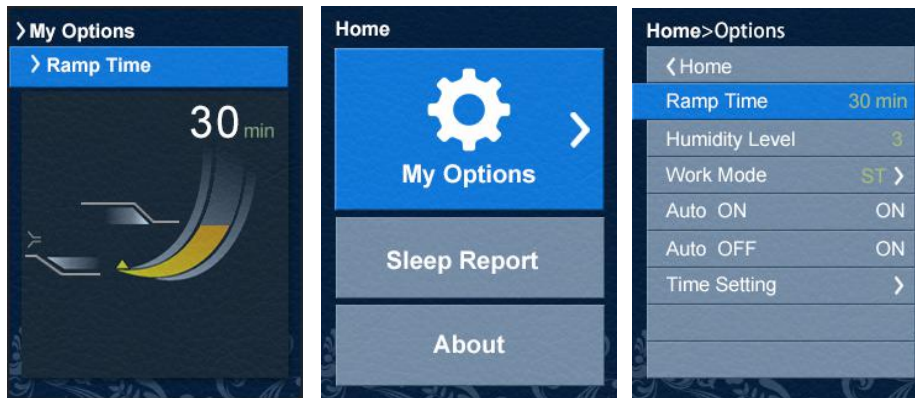

1. In Options, press enter button to highlight Ramp Time.
2. Press up/down button to adjust the ramp time to your preferred setting.
3. Press enter button to save the change.

## Humidity Level

The humidifier moistens the air and is designed to make therapy more comfortable. Can set the Humidity Level to off (0) or between 1 and 5, where 1 is the lowest humidity setting and 5 is the highest humidity setting.

### To adjust the Humidity Level:

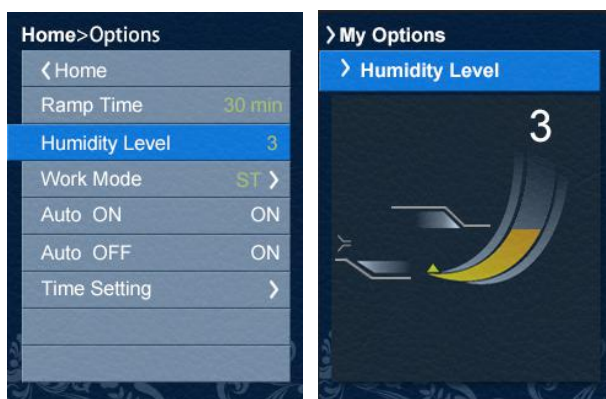

1. In Options, press enter button to highlight Humidity Level.
2. Press up/down button to adjust humidity level.
3. Press enter button to save the change.



# Work Mode

**CPAP mode for DS-5 CPAP.**

**CPAP, Auto mode for DS-6 Auto CPAP.**

**CPAP, Auto, S, T, ST mode for DS-7 BIPAP ST25.**

**CPAP, Auto, S, T, ST, APCV mode for DS-8 BIPAP ST30.**

## To Unlock Work Mode parameters

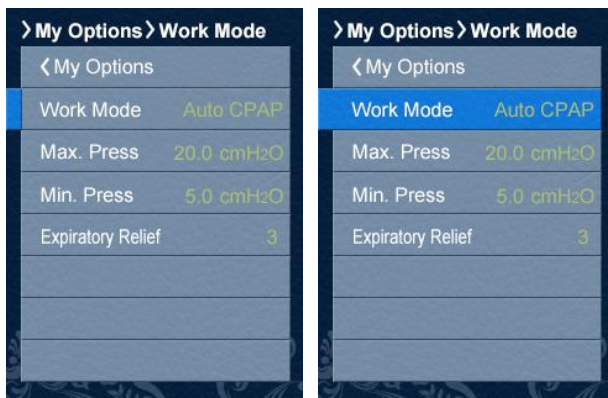

1. Work Mode parameters will be locked automatically after setting in 15 minutes.
2. Long press enter button over 5 seconds to highlight the column to unlock.  
To adjust the working pressure

## To adjust the working pressure

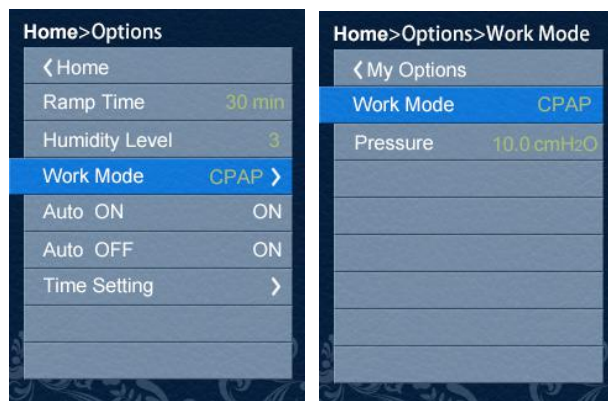

1. In work mode CPAP, press enter button to highlight Pressure. Press up/down button to adjust working pressure. You can set pressure 4-20 cmH2O for CPAP mode.

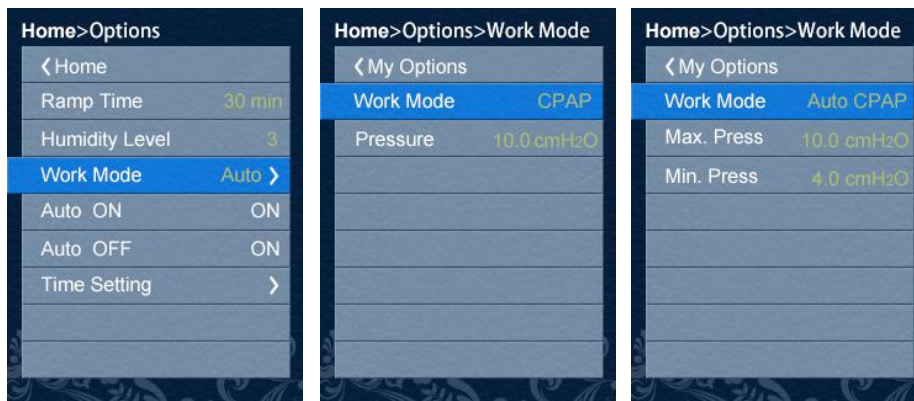

2. In work mode Auto CPAP, press enter button to highlight Pressure. Press up/down button to adjust Max and Min working pressure. You can set pressure 4-20 cmH<sub>2</sub>O for Auto CPAP mode.



3. In work mode S, T, ST, press enter button to highlight IPAP (Inspirate Positive

Airway Pressure) . Press up/down button to adjust IPAP working pressure. You can set pressure 4-25 cmH<sub>2</sub>O for DS-7 BIPAP ST25 and 4-30 cmH<sub>2</sub>O for DS-8 BIPAP ST30



- In work mode S, T, ST, press enter button to highlight EPAP (Expirate Positive Airway Pressure). Press up/down button to adjust EPAP working pressure. You can set pressure 4-20 cmH<sub>2</sub>O for DS-7 BIPAP ST25 and DS-8 BIPAP ST30. Attention: Inspirate pressure must be higher than expirate pressure.

### To adjust Backup Rate

Designed to set device inspire and expirate therapy times in 1 minute. You can set 5-50bpm in mode T & ST.

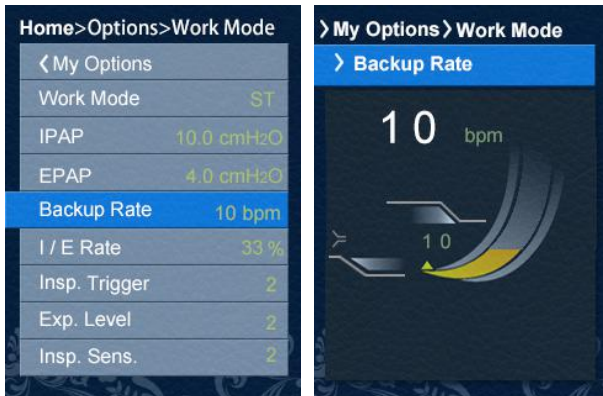
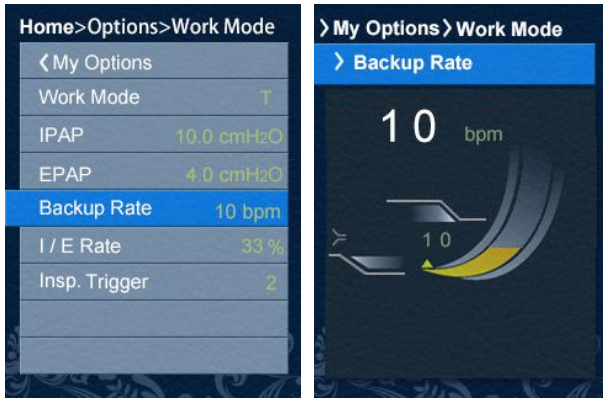

## TO adjust I/E Rate

Designed to set device different inspirate and expirate therapy percentage in a whole therapy duration. You can set 10%-80% in mode T & ST.

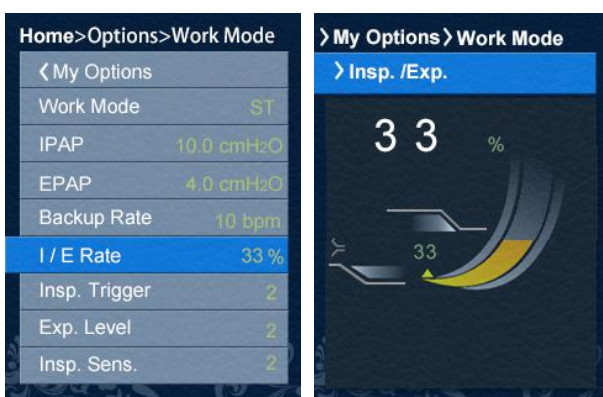
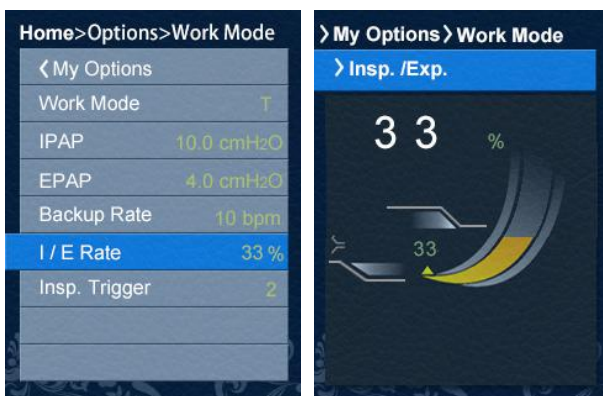

## TO adjust Inspirate Trigger

You can set 1-5 in mode S/T/ST, “1” is the most sensitive, “5” is the slowest.

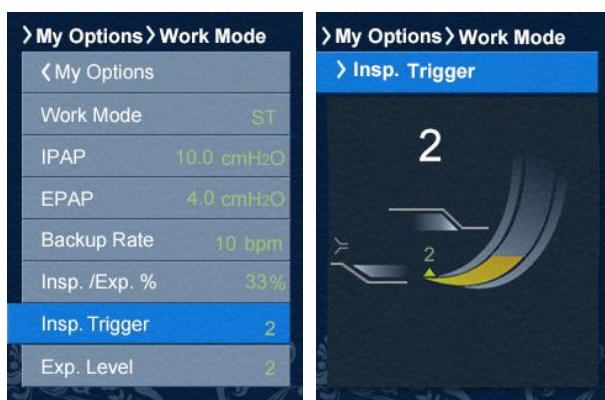
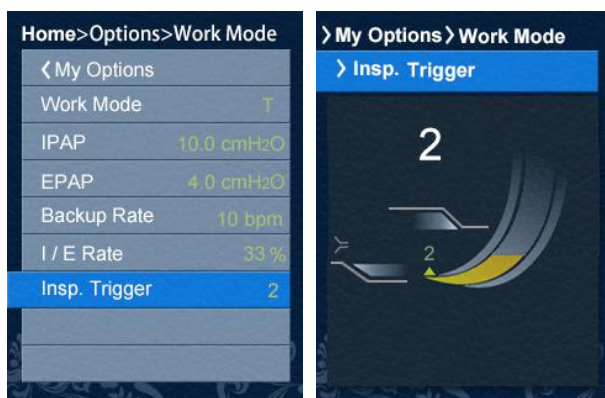

## TO adjust Expirate Level

You can set 1-5 in mode S & ST, “1” is the most sensitive, “5” is the slowest.

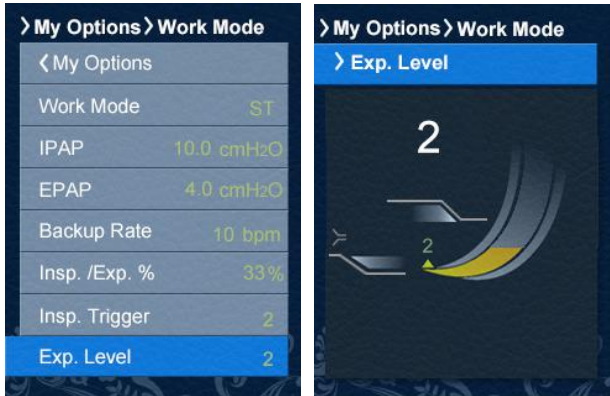

## TO adjust Inspirite Sensitivity

You can set 1-5 in mode S & ST, “1” is the most sensitive, “5” is the slowest.

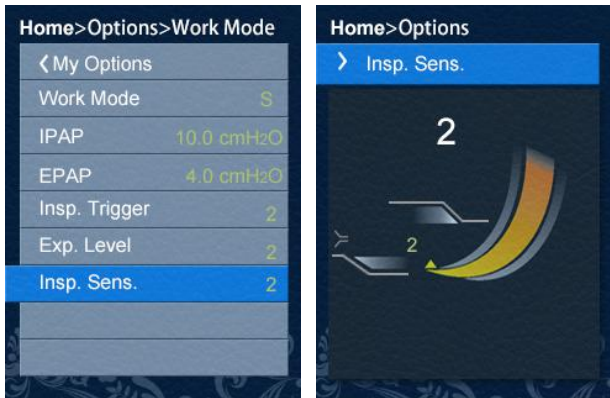

## To set APCV mode

In APCV mode, you can set IPAP/EPAP/Backup Rate/Inspirate Trigger/ Expirate Level/Inspirate Sensitivity, the adjust process is same as ST mode.

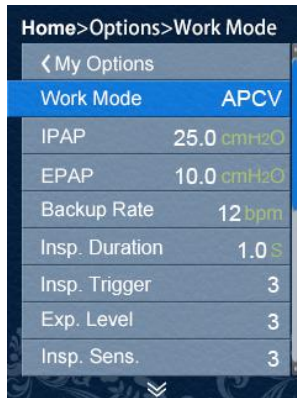

## To adjust Inspirate Duration

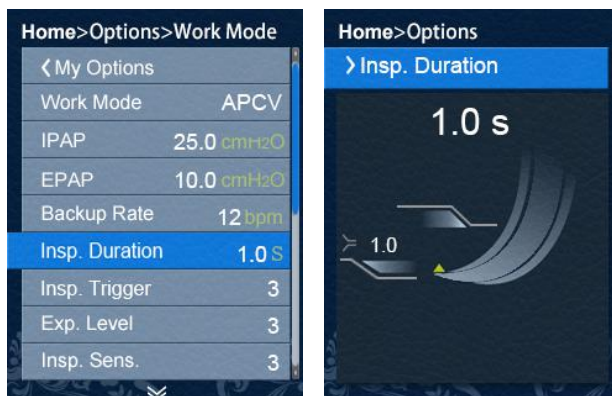

You can set from 0.5 seconds to 4 seconds.

## TV. V. Switch

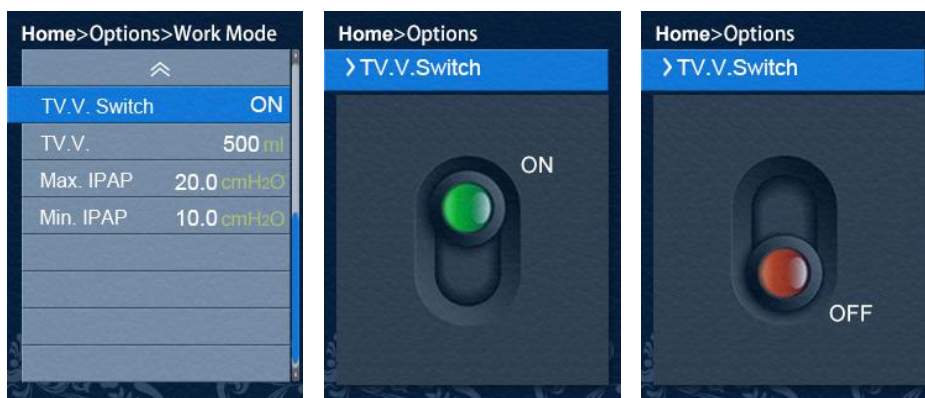

Designed to set target tidal volume ON or OFF.

## To adjust TV.V.

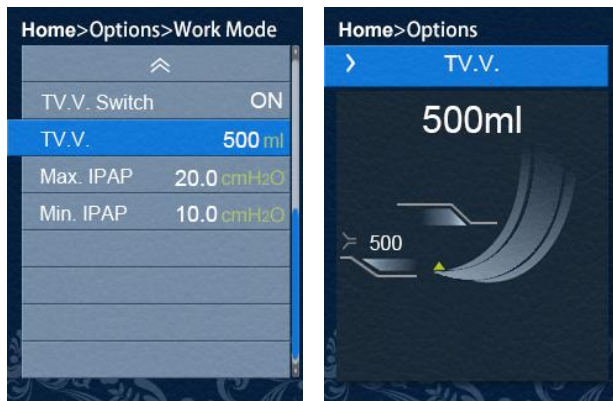

Designed to set target tidal volume, you can set from 200mL to 1200mL.

## To adjust Max. IPAP

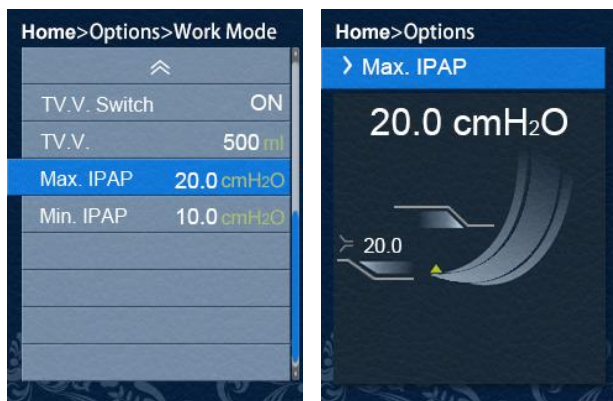

Designed to set maximum IPAP (Inspirate Positive Airway Pressure), you can set from 10 cmH<sub>2</sub>O to 30 cmH<sub>2</sub>O.

## To adjust Min. IPAP

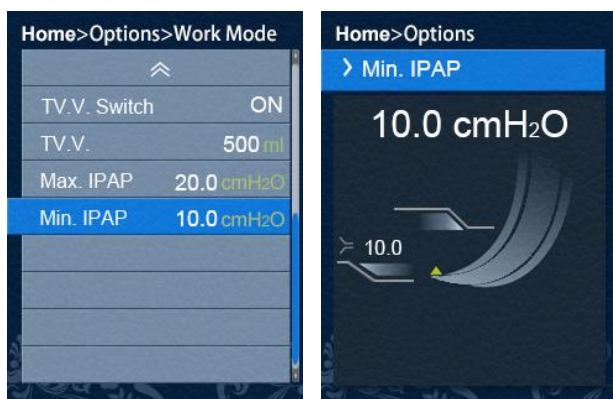

Designed to set minimum IPAP (Inspirate Positive Airway Pressure), you can set from 4 cmH<sub>2</sub>O to 20 cmH<sub>2</sub>O.



## Auto ON

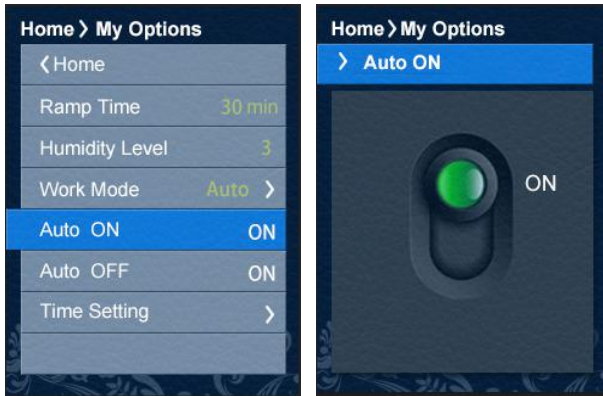

Designed to make the device start automatically in a while after you wear mask.

## Auto OFF

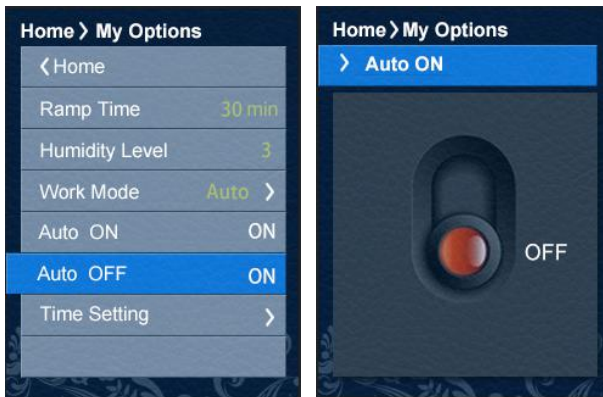

Designed to stop the device work automatically in 10seconds after you take mask away.

## Time Setting

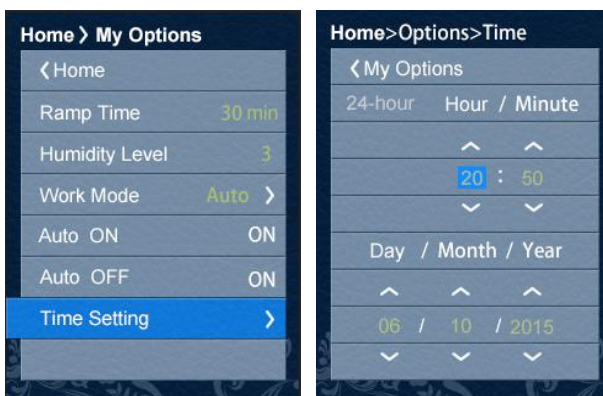

## Pressure Relief

The device already automatically set EPR (Expiratory Pressure Relief) function; you may find it easier to breathe out. This can help you get used to therapy.

Can set the expiratory pressure relief Level to off (0) or between 1 and 3, where 1 is the lowest expiratory pressure relief and 3 is the highest setting.

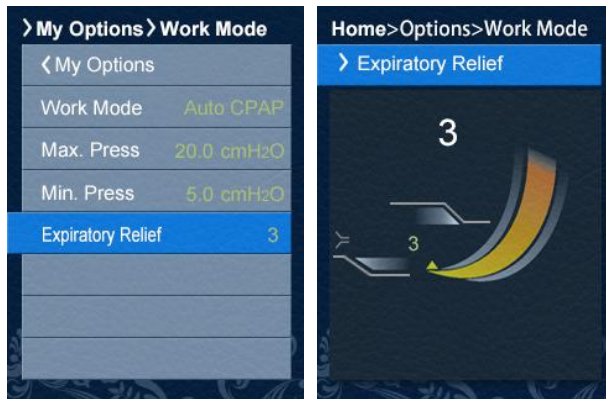

## Caring for device

It is important that you regularly clean the device to make sure device work normally. The following sections will help you with disassembling, cleaning, checking and reassembling the device.

## Disassembling

1. Open the water tank cover, take water tank away from the device.
2. Open the water tank and discard any remaining water.
3. Hold the cuff of the air tubing and gently pull it away from the device.

## Cleaning

Clean the device weekly as described. Refer to the mask user guide for detailed instructions on cleaning your mask.

1. Wash the water tank and air tubing in warm water using mild detergent. Do not wash in a dishwasher or washing machine.

2. Rinse the water tank and air tubing thoroughly and allow to dry out of direct sunlight and/or heat.
3. Wipe the exterior of the device with a dry cloth.

## Checking

Regularly check the water tank, air tubing and the air filter for any damage.

1. Check the water tank:
  - ◆ Replace it if it is leaking or has become cracked, pitted or cloudy.
  - ◆ Replace it if the seal is cracked or torn.
  - ◆ Remove any white powder deposits using a solution of one part household vinegar to 10 parts water.
2. Check the air filter and replace it at least every six months. Replace it more often if there are any holes or blockages by dirt or dust.

## To replace the air filter:

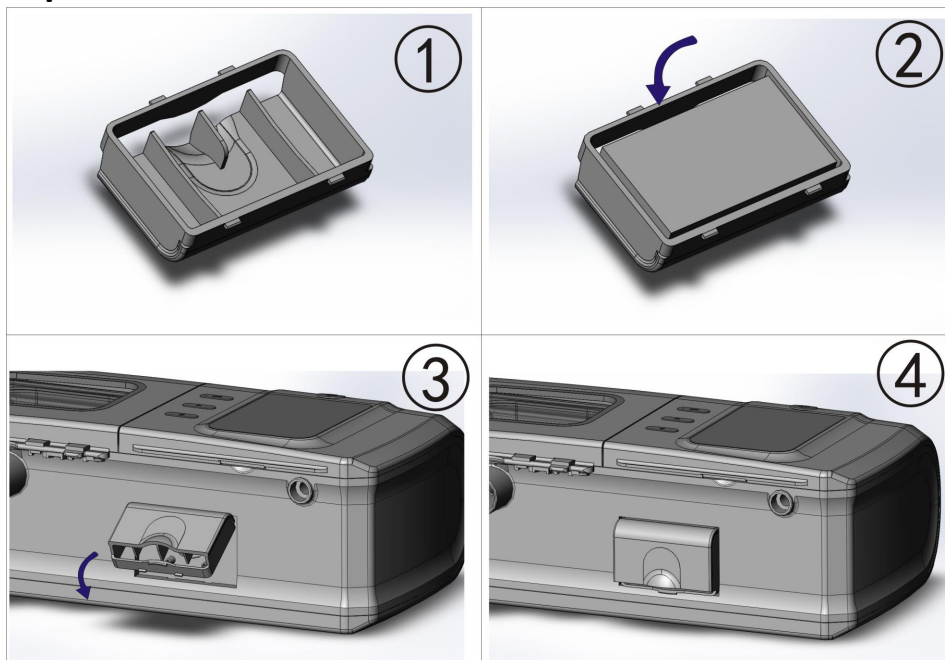

- ◆ Open the air filter cover and remove the old air filter. The air filter is not washable or reusable.
  - ◆ Place a new air filter then close the air filter cover.
  - ◆ Make sure the air filter is fitted at all times to prevent water and dust from entering the device.
3. Check the air tubing and replace it if there are any holes, tears or cracks.

## Reassembling

When the water tank and air tubing are dry, can begin to reassemble the parts.

1. Connect the air tubing firmly to the air outlet located on the rear of the device.
2. Fill the water tank with distilled room temperature water up to the maximum water level mark.
3. Put water tank into the device. Close the water tank cover.
4. Connect the free end of the air tubing firmly onto the mask.

## Therapy data

The device records therapy data for you and your care provider so they can view and make changes to your therapy if required. The data is recorded via a SD card. You can send SD card to your care provider by mail. When instructed by your care

provider, remove the SD card.

Do not remove the SD card from the device when the device is working.

### To remove the SD card:

1. Stop the device.
2. Push in the SD card to release it. Remove the SD card from the device.

Place the SD card in the protective folder and send it back to your care provider.

Note: The SD card should insert in correct, should not be used for any other purpose.

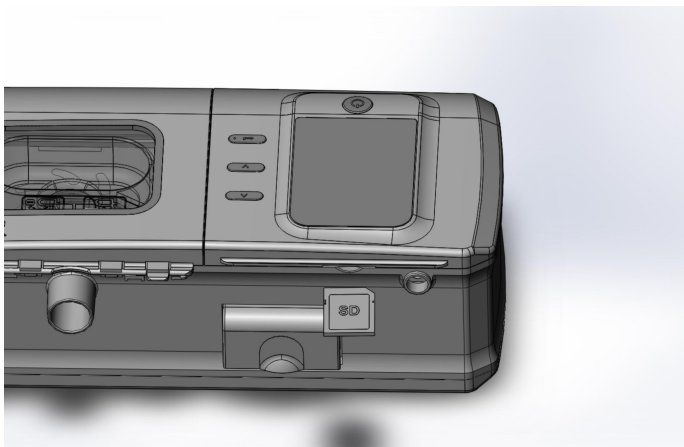

## Traveling

You can take this device with you wherever you go. Just keep the following in mind:

- ◆ Empty the water tank and put it into the device.
- ◆ Make sure you have the appropriate power cord for the region you are traveling to. For information on purchasing, contact your care provider.
- ◆ Use the travel bag provided to prevent damage to the device.
- ◆ If you are using an external battery, should turn off the humidifier in order to maximize the life of your battery. Do this by turning the Humidity Level to Off.

### CAUTION

Do not use the device with water in the water tank on a plane due to the risk of inhalation of water during turbulence.

## Troubleshooting

If you have any problems, have a look at the following troubleshooting topics. If you are not able to fix the problem, contact your care provider. Do not try to open the device.

<b>Problem/possible cause</b>	<b>Solution</b>
<b>Air is leaking from around mask</b> Mask may be fitted incorrectly.	Make sure mask is fitted correctly and firmly. Read your mask user guide for detailed information.
<b>Air pressure in mask seems too high (it feels like getting too much air)</b> Ramp may be turned off.	Use the Ramp Time option.
<b>Air pressure in mask seems too low (it feels like I am not getting enough air)</b> Ramp may be in progress.	Wait for air pressure to build up or turn Ramp Time off.
<b>My water tank is leaking</b> Water tank may not be assembled correctly. Water tank may be damaged or cracked.	Check for damage and reassemble the water tank correctly. Contact your care provider for a replacement.
<b>Nose is feeling dry or blocked</b> Humidity level may be set too low.	Adjust the Humidity Level.
<b>Screen is black</b> Backlight on the screen may have turned off. It turns off automatically after a short time. Power may not be connected.	Press any button to turn it back on. Connect the power supply and make sure the plug is fully inserted.
<b>Have stopped therapy, but the device is still blowing air</b> Device is cooling down.	Device blows a small amount of air in order to avoid condensation in the air tubing. It will stop automatically after 20 minutes.

Problem/possible cause	Solution
<p><b>High leak detected, check water tank, tank seal or water tank cover</b></p> <p><b>Water tank may not be inserted properly.</b></p> <p><b>Water tank seal may not be inserted properly.</b></p>	<p>Make sure the water tank is correctly inserted.</p> <p>Open the water tank and make sure that the seal is correctly inserted.</p>
<p><b>Droplets of water on nose, in the mask and air tubing</b></p> <p>Humidity level may be set too high.</p>	<p>Adjust the Humidity Level.</p>
<p><b>Mouth is very dry and uncomfortable</b></p> <p>Air may be escaping through mouth.</p>	<p>Increase the Humidity Level.</p> <p>You may need a chin strap to keep your mouth closed or a full face mask.</p>
<p><b>High leak detected, connect your tubing</b></p> <p>Air tubing may not be connected properly.</p> <p>Mask may be fitted incorrectly.</p>	<p>Make sure the air tubing is firmly connected at both ends.</p> <p>Make sure mask is fitted correctly. See your mask user guide for fitting instructions or use the Mask Fit function to check your mask fit and seal.</p>
<p><b>Tubing blocked, check your tubing</b></p> <p>Air tubing may be blocked.</p>	<p>Check the air tubing and remove any blockages.</p>
<p><b>SD card error</b></p> <p>SD card may not be inserted correctly.</p>	<p>Power off the device, remove and reinsert the SD card.</p>
<p><b>Air filter blocked</b></p>	<p>Check the air filter and replace it if there are any blockages.</p>
<p><b>Water in the air tubing</b></p>	<p>Empty the water from the air tubing.</p> <p>Disconnect the power supply and then reconnect it to restart the device.</p>
<p><b>All other error messages</b></p>	<p>Contact your care provider. Do not open the device.</p>

## Reassembling parts

Water tank is designed to easily come off in order to avoid damage to the parts or the device. You can easily reassemble them as described below.

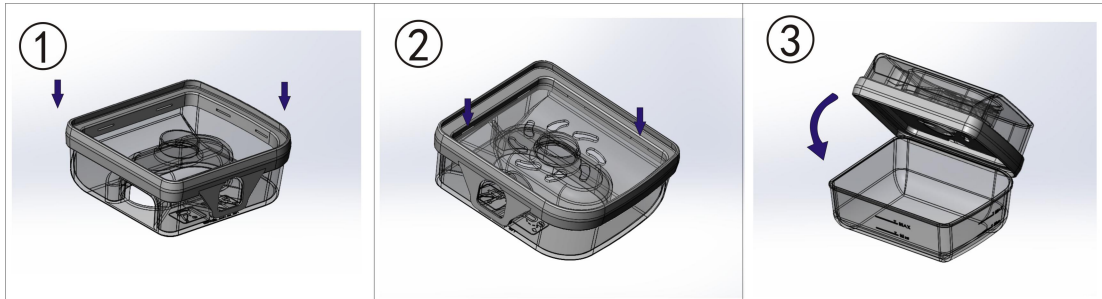

### To insert the water tank seal:

1. Place the seal into bottom water tank.
2. Press down along all edges of the seal until it is firmly in place.

### To reassemble the water tank:

1. Insert both up water tank into bottom water tank and sealed both sides.

## General warnings and cautions

### **WARNING**

- ◆ Make sure that you arrange the air tubing correctly so that it will not twist around the head or neck.
- ◆ Keep the power cord away from water source or hot surfaces.
- ◆ Make sure the power cord and plug are in good condition and the device is not damaged.
- ◆ Do not open or modify the device. Repairs and servicing should only be performed by your care provider.
- ◆ Beware of electrocution. Do not immerse the device, power supply or power cord in water. If liquids are spilled into or onto the device, unplug the device and let the parts dry. Always unplug the device before cleaning and make sure that all parts are dry before plugging it back in.
- ◆ If you notice any unexplained changes in the performance of the device, if it is making unusual sounds, if the device or the power supply are dropped or



mishandled, or if the enclosure is broken, discontinue use and contact your care provider.

- ◆ Supplemental oxygen must not be used while smoking or in the presence of an open flame.
- ◆ Always make sure that the device is turned on and airflow generated before the oxygen supply is turned on. Always turn the oxygen supply off before the device is turned off, so that unused oxygen does not accumulate within the device enclosure and create a risk of fire.
- ◆ Sources of oxygen must be located more than 1 m from the equipment to avoid the risk of fire and burns.
- ◆ Do not perform any maintenance tasks while the device is in operation.

### **CAUTION**

- ◆ Use only compliant parts and accessories with the device. Non-compliant parts may reduce the effectiveness of the treatment and/or damage the device.
- ◆ Be careful not to place the device where it can be bumped or where someone is likely to trip over the power cord.
- ◆ Use only masks recommended by us or by the prescribing doctor with this device. Fitting the mask without the device blowing air can result in rebreathing of exhaled air. Make sure that the mask vent holes are kept clear and unblocked to maintain the flow of the fresh air into the mask.
- ◆ Keep the device dry, clean and clear of anything (eg, clothes or bedding) that could block the air inlet or cover the power supply unit.
- ◆ Do not place the device on its side as water might get into the device.
- ◆ Do not block the air tubing and/or air inlet of the device while in operation as they could lead to overheating of the device.
- ◆ Incorrect system setup may result in incorrect mask pressure reading. Ensure the system is correctly set up.
- ◆ Make sure that the water tank is empty before transporting the device.
- ◆ When use the humidifier, please always place the device on a level surface lower than your head to prevent the mask and air tubing from filling with water.
- ◆ Leave the water tank to cool for ten minutes before handling to allow the water to cool and to make sure that the water tank is not too hot to touch.
- ◆ Do not use bleach, chlorine, alcohol, or aromatic-based solutions, moisturizing

or antibacterial soaps or scented oils to clean the device, the water tank or air tubing. These solutions may cause damage or affect the humidifier performance and reduce the life of the products.

- ◆ Periodically reassess the setting(s) of the therapy for effectiveness.

## Technical specifications

Type	Item	Specifications
60W power supply unit (Only use with IEC60601-1 approved adaptor)	AC input range	100–240V~, 50–60Hz, 2A maximum, Class II
	DC output	24V===2.5A
Environmental conditions	Operating temperature	+41°F to +95°F (+5°C to +35°C) Note: The air flow for breathing produced by this therapy device can be higher than the temperature of the room. Under extreme ambient temperature conditions (104°F/40°C) the device remains safe.
	Operating humidity:	10 to 95% relative humidity, non-condensing
	Operating altitude	Sea level to 8,500' (2,591 m); air pressure range 1013 hPa to 738 hPa
	Storage and transport temperature	-4°F to +140°F (-20°C to +60°C)
	Storage and transport humidity	5 to 95% relative humidity, non-condensing
Electromagnetic compatibility	The device complies with all applicable electromagnetic compatibility requirements (EMC) according to IEC60601-1-2:2014, for	

	residential, commercial and light industry environments	
IEC 60601-1:2005+A1:2012 classification	Class II (double insulation), Type BF, Ingress protection IPX1.	
Sensors	Pressure sensor	Internally located at device outlet, analog gauge pressure type, 0 to 40 cm H <sub>2</sub> O
	Flow sensor	Internally located at device outlet, analog gauge flow type, 50 to +200 L/min
Maximum single fault steady pressure	Device will shut down in the presence of a single fault if the steady state pressure exceeds: 35 cm H <sub>2</sub> O for more than 1 sec.	
Sound	Pressure level measured according to ISO 80601-2-70 (CPAP mode) Declared dual-number noise emission values in accordance with ISO 4871:1996.	53 dBA with uncertainty of 2 dBA under background sound level 36 dBA A-weighted sound power level is 61 dBA under background sound level 36 dBA
Physical-device and water tank	Dimensions (H x W x D):	280 mm x 140 mm x 95 mm
	Air outlet (complies with ISO 5356-1:2004)	22 mm
	Weight (device and water tank)	1.6 kgs
	Water capacity	To maximum fill line 220 mL, minimum 100 mL
	Water tank - material	Injection molded plastic and silicone seal
Temperature	Maximum heater plate	68°C
	Cut-out	102°C

User Guide

	Maximum gas temperature	41°C
Operating pressure range(IPAP)	DS-5 CPAP DS-6 Auto CPAP DS-7 BIPAP ST25 DS-8 BIPAP ST30	4 to 20 cm H2O 4 to 20 cm H2O 4 to 25 cm H2O 4 to 30 cm H2O
Operating pressure range(EPAP)	DS-5 CPAP DS-6 Auto CPAP DS-7 BIPAP ST25 DS-8 BIPAP ST30	4 to 20 cmH2O
Air Filter		Material: Polyester non woven fiber Average arrestance: >75% for ~7 micron dust
Design life	Device, power supply unit	5 years
	Water tank, air tubing	6 months

Notes:

- ◆ Manufacturer will provide circuit diagrams, component part lists, descriptions, calibration instructions to assist to service personnel in parts repair.
- ◆ Manufacturer reserves the right to change specifications without notice.
- ◆ The temperature and relative humidity settings displayed are not measured values. Do not use electrically conductive or antistatic air tubing.

Pneumatic flow path

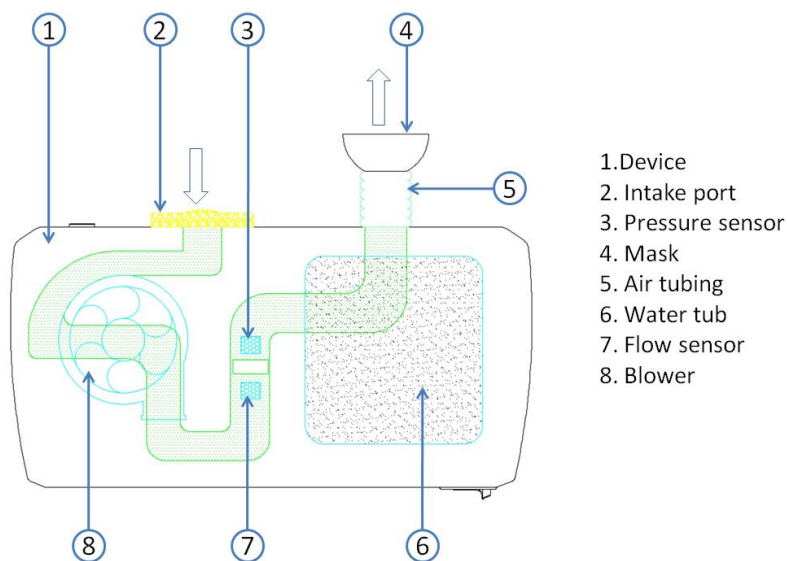

**Displayed values**

Value	Range	Display resolution
Pressure sensor at air outlet: Mask pressure	DS-5 CPAP	0.1 cmH <sub>2</sub> O
	DS-6 Auto CPAP	0.1cmH <sub>2</sub> O
	DS-7 BIPAP ST25: 4–25 cmH <sub>2</sub> O	0.1 cmH <sub>2</sub> O
	DS-8 BIPAP ST30: 4-30 cmH <sub>2</sub> O	0.1 cmH <sub>2</sub> O

**Value Accuracy**

Value	Accuracy
Static Airway Pressure measurement: Mask pressure	$\pm 0.5\text{cmH}_2\text{O} + 4\%$ of the set pressure
Dynamic Airway Pressure measurement(Both Cpap/BIPAP): Mask pressure	$\pm 3\text{cmH}_2\text{O} + 5\%$ of the set pressure  The percentage of each inspiratory and expiratory phase to be taken into the calculation for determining the accuracy is (I/E=1:1)
Remark: Results are expressed at ATPD (Ambient Temperature and Pressure, Dry).	













**Environmental information**

This device should be disposed of separately, not as unsorted municipal waste. To dispose of your device, you should use appropriate collection, reuse and recycling systems available in your region. The use of these collection, reuse and recycling systems is designed to reduce pressure on natural resources and prevent hazardous substances from damaging the environment.

If you need information on these disposal systems, please contact your local waste administration. The crossed-bin symbol invites you to use these disposal systems. If you require information on collection and disposal of the device please contact your care provider.

# Symbols

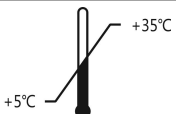
The following symbols may appear on the product or packaging.

	Indicates a warning or caution
	Serial number
	Type BF applied part
	Maximum water level
	Caution! Hot Surface. Do not touch.
	Water proof Grade 1
	Manufacturer
	European Authorized Representative
	Environmental information
	Follow instructions before use
	Direct current
	Temperature limitation
	Humidity limitation
	Manufacturer Date

## Limited warranty

We warrant that your product shall be free from defects in material and workmanship from the purchase date for the period specified below.

Product	Warranty period
Humidifier water tanks	90days
CPAP, BIPAP devices (including external power supply units)	2 years
Humidifier	2 years

This warranty is only available to the initial consumer. It is not transferable.

If the product fails under conditions of normal use, we will repair or replace, at its option, the defective product or any of its components.

This Limited Warranty does not cover:

- a) Any damage caused as a result of improper use, abuse, modification or alteration of the product;
- b) Repairs carried out by any service organization that has not been expressly authorized by us to perform such repairs;
- c) Any damage or contamination due to cigarette, pipe, cigar or other smoke.

Warranty is void on product sold, or resold, outside the region of original purchase.

Warranty claims on defective product must be made by the initial consumer at the point of purchase.

This warranty replaces all other expressed or implied warranties, including any implied warranty of merchantability or fitness for a particular purpose. Some regions or states do not allow limitations on how long an implied warranty lasts, so the above limitation may not apply to you.

We shall not be responsible for any incidental or consequential damages claimed to have resulted from the sale, installation or use of any our product.

### Further information

If you have any questions or require additional information on how to use the device, contact your care provider.

# Technical Description Concerning Electromagnetic Immunity

**Table 3: Guidance & Declaration - electromagnetic immunity**

<b>Guidance &amp; Declaration — electromagnetic immunity</b>			
The models DS-5, DS-6, DS-7, DS-8 are intended for use in the electromagnetic environment specified below. The customer or the user of the models DS-5, DS-6, DS-7, DS-8 should assure that It is used in such an environment.			
<b>Immunity test</b>	<b>IEC 60601 test level</b>	<b>Compliance level</b>	<b>Electromagnetic environment - guidance</b>
Electrostatic discharge (ESD) IEC 61000-4-2	±8 kV contact ±2 kV, ±4 kV, ±8 kV, ±15 kV air	±8 kV contact ±2 kV, ±4 kV, ±8 kV, ±15 kV air	Floors should be wood, concrete or ceramic tile. If floors are covered with synthetic material, the relative humidity should be at least 30%.
Electrical fast transient/burst IEC 61000-4-4	±2kV for power supply lines ±1 kV for Input/output lines	±2kV for power supply lines ±1kV for interconnecting cable	Mains power quality should be that of a typical commercial or hospital environment.
Surge IEC 61000-4-5	±1 kV line to line ±2 kV line to earth	±1 kV line to line	Mains power quality should be that of a typical commercial or hospital environment.
Voltage dips, short interruptions and voltage variations on power supply input lines	<5 % <i>UT</i> (>95% dip in <i>UT</i> ) for 0.5 cycle 40 % <i>UT</i> (60% dip in <i>UT</i> ) for 5 cycles 70% <i>UT</i> (30% dip in <i>UT</i> )	<5 % <i>UT</i> (>95% dip in <i>UT</i> ) for 0.5 cycle 40 % <i>UT</i> (60% dip in <i>UT</i> ) for 5 cycles 70% <i>UT</i> (30% dip in <i>UT</i> ) for 25 cycles	Mains power quality should be that of a typical commercial or hospital environment. If the user of the models DS-5, DS-6, DS-7, DS-8 require continued operation during power mains interruptions, it is recommended that the models DS-5, DS-6, DS-7, DS-8



IEC 61000-4-11.	for 25 cycles <5% <i>UT</i> (>95 % dip in <i>UT</i> ) for 5 sec	<5% <i>UT</i> (>95 % dip in <i>UT</i> ) for 5 sec	be powered from an uninterruptible power supply or a battery.
Power frequency (50-60 Hz) magnetic field IEC 61000-4-8	30 A/m	30 A/m	Power frequency magnetic fields should be at levels characteristic of a typical location in a typical commercial or hospital environment.

NOTE *UT* is the a.c. mains voltage prior to application of the test level.

## Annex A: Electromagnetic Compatibility Information

**Guidance and manufacturer's declaration** - electromagnetic emissions– this device is intended for use in the electromagnetic environment specified below.

The user of the device should ensure that it is used in such an environment.

Emissions Test	Compliance	Electromagnetic environment-guidance
RF emissions CISPR11	Group 1	The device uses RF energy only for its internal function. Therefore its RF emissions are very low and are not likely to cause any interference in nearby electronic equipment.
RF emissions CISPR11	Class B	This device is suitable for use in all establishments, including domestic establishments and those directly connected to the public low-voltage power supply network that supplies buildings used for
Harmonic emissions IEC61000-3-2	Class A	
Voltage fluctuation	Conformity	

/flicker emissions IEC61000-3-3		domestic purposes.
------------------------------------	--	--------------------

**Guidance and manufacturer's declaration** - electromagnetic immunity – this device is intended for use in the electromagnetic environment specified below. The user of the device should make sure that it is used in such an environment.

Immunity test	IEC60601 test level	Compliance level	Electromagnetic environment-guidance
Electrostatic discharge (ESD) IEC61000-4-2	±6KV contact ±8KV air	±6KV contact ±8KV air	Floor should be wood, concrete or ceramic tile. If floors are covered with synthetic material, the relative humidity should be at least 30%.
Electrical fast transient / burst IEC61000-4-4	±2KV for power supply lines ±1KV for input/output lines	±2KV for power supply lines ±1KV for input/output lines	Mains power quality should be that of a typical home or hospital.
Surge IEC61000-4-5	±1K differential mode ±2KV common mode	±1KV differential mode ±2KV common mode	Mains power quality should be that of a typical home or hospital.

Immunity test	IEC60601 test level	Compliance level	Electromagnetic environment-guidance
<p>Voltage dips, short interruptions and voltage variations on power supply input lines</p> <p>IEC61000-4-11</p>	<p>&lt;5% <math>U_T</math> (&gt;95% dip in <math>U_T</math>), for 0.5 cycle</p> <p>40% <math>U_T</math> (60% dip in <math>U_T</math>), for 5 cycles</p> <p>70% <math>U_T</math> (30% dip in <math>U_T</math>) for 25 cycles</p> <p>&lt;5% <math>U_T</math> (&gt;95% dip in <math>U_T</math>) for 5 s</p>	<p>&lt;5% <math>U_T</math> (&gt;95% dip in <math>U_T</math>), for 0.5 cycle</p> <p>40% <math>U_T</math> (60% dip in <math>U_T</math>), for 5 cycles</p> <p>70% <math>U_T</math> (30% dip in <math>U_T</math>) for 25 cycles</p> <p>&lt;5% <math>U_T</math> (&gt;95% dip in <math>U_T</math>) for 5 s</p>	<p>Main power quality should be that of a typical commercial or hospital environment. If the use of the device requires continued operation during power mains interruptions, it is recommended that the device be powered from an uninterruptible power supply or from a battery.</p>
<p>Power frequency (50/60Hz) magnetic field</p> <p>IEC61000-4-8</p>	<p>3A/m</p>	<p>3A/m</p>	<p>Power frequency magnetic field shall be typical level of power frequency magnetic fields in hospital or home environment.</p>

Note:  $U_T$  is the AC mains voltage prior to application of the test level.

**Guidance and manufacturer's declaration** - electromagnetic immunity – this device is intended for use in the electromagnetic environment specified below. The user of the device should make sure that it is used in such an environment.

Immunity test	IEC60601 test level	Compliance level	Electromagnetic environment-guidance
<p>Conducted RF IEC61000-4-6</p>	<p>3Vrms 150kHz to 80MHz</p>	<p>3Vrms</p>	<p>Portable and mobile RF communications equipment should be used no closer to any part of the device, including cables, than the recommended separation distance calculated from the equation application to the frequency of the transmitter.</p> <p>Recommended separation distance</p> <p><math>d=1.2 \sqrt{p}</math></p> <p>80MHz to 800MHz</p> <p><math>d=2.3 \sqrt{p}</math></p> <p>800MHz to 2.5GHz</p>

Immunity test	IEC60601 test level	Compliance level	Electromagnetic environment-guidance
<p>Radiated RF IEC61000-4-3</p>	<p>3V/m 80MHz to 2.5GHz</p>	<p>3V/m</p>	<p>Where <math>P</math> is the maximum output power rating of the transmitter in watts (W) according to the transmitter manufacturer and <math>d</math> is the recommended separation distance in meters (m).</p> <p>Field strengths from fixed RF transmitter, as determined by an electromagnetic site survey, should be less than the compliance level in each frequency range.</p>

Immunity test	IEC60601 test level	Compliance level	Electromagnetic environment-guidance
			Interference may occur in the vicinity of equipment marked with the following symbol: 

Note 1: At 80MHz, the higher frequency range applied.

Note 2: These guidelines may not be applied in all situations. Electromagnetic propagation is affected by absorption and reflection from structures, objects and people.

a. Field strengths from fixed transmitters, such as base stations for radio (cellular / cordless) telephones and land mobile radios, amateur radio, AM and FM radio broadcast and TV broadcast cannot be predicted theoretically with accuracy. To assess the electromagnetic environment due to fixed RF transmitters, an electromagnetic site survey should be considered. If the measured field strength in the location in which the device is used exceeds the applicable RF compliance level above, the device should be observed to verify normal operation. If abnormal performance is observed, additional measures may be necessary, such as re-orienting or relocating the device.

b. Over the frequency range 150kHz to 80MHz, the field strengths should be less than 3 V/m.

## Maximum flow rate

## 1. CPAP

Pressure(cmH2O)	Maximum flow rate(L/Min)
4	77
8	111
12	140
16	158
20	164

## 2. BIPAP

Pressure(cmH2O)	Maximum flow rate(L/Min)
4	77
9	119
15	156
20	164
25	164
30	164